

CARPAS ESTÁNDAR

Serie 4m

4x4 - 4x6 - 4x8

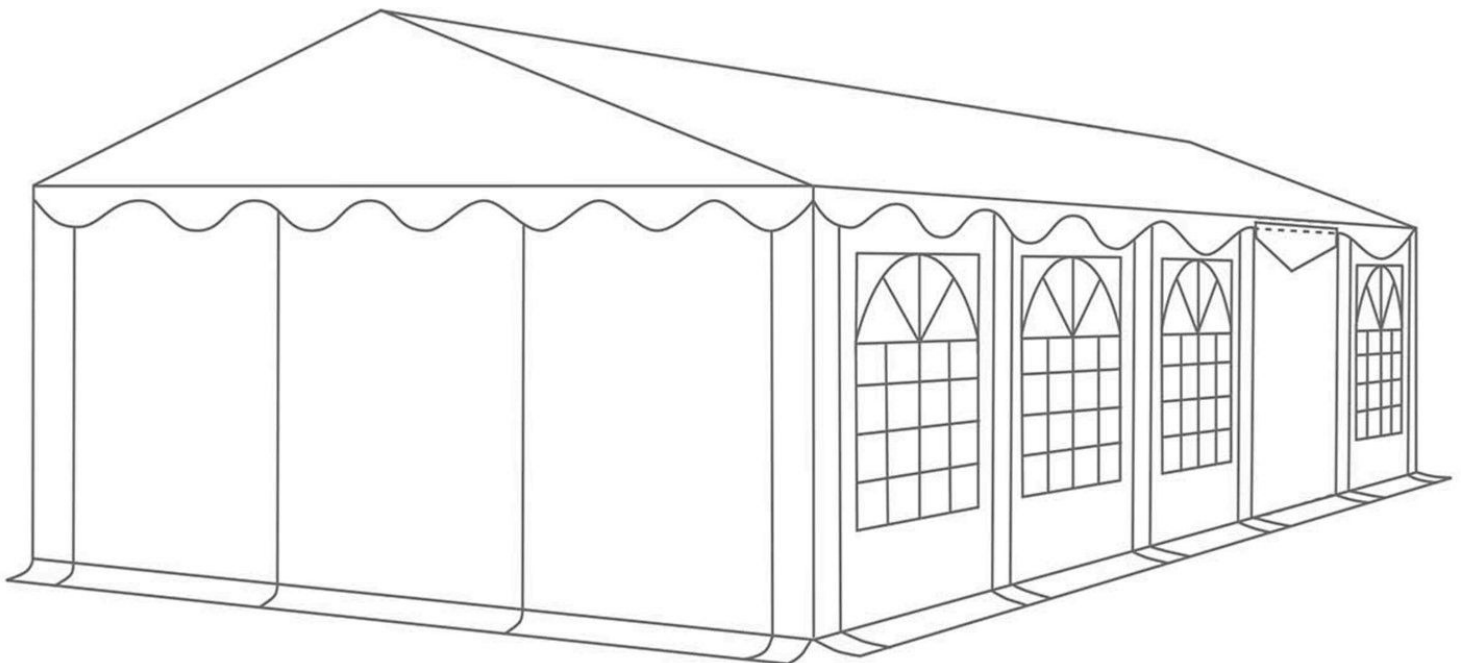







ES - Manual de instrucciones Carpa PVC (página 2)

EN - Assembly instruction PVC-Tent (page 7)

FR - Mode d'emploi PVC-Tente (page 12)

PO - Manual de instruções Tente PVC (página 17)

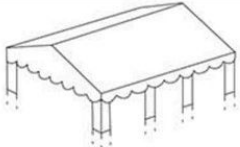
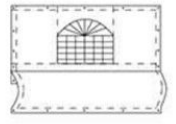
Nº de art.	Descripción	Nº de ident.		4x4m	4x6m	4x8m
30063	Barra 2.160 mm 38-38	1		6	8	10
30055	Barra 1.940 mm 38-38	2		6	9	12
30435	Barra 1.920 mm 38-38 con agujeros y pie	3		6	8	10
30073	Conector angular triple 120°	4		6	6	6
30074	Conector angular cuádruple 120°	5		3	6	9
30048	Clavo de tierra 8x300 mm	6		4	4	4
30046	Clavo de tierra 6x180 mm	7		6	8	10
30047	Clavo de tierra 4x180 mm	8		28	36	40
30430	Pasador de goma 14 cm tipo 1	9		66	84	102
30429	Pasador de goma 5 cm tipo 1	10		18	18	18
30050	Cuerda tensora 3 m	11		4	4	4
30383	Tornillo 10 mm	12		30	42	54
30051	Gancho de techo	13		4	8	10
	Techo	14		1	1	1
	Pared lateral	15		4	6	8
	Pared final	16		2	2	2

1

Busque una superficie llana para instalar la carpa. Abra el embalaje y compruebe si están todas las piezas que aquí se enumeran.

Ensamble el armazón del techo montando las piezas 4 y 5 en las barras (piezas 1 y 2) y apriete los tornillos para fijarlas.

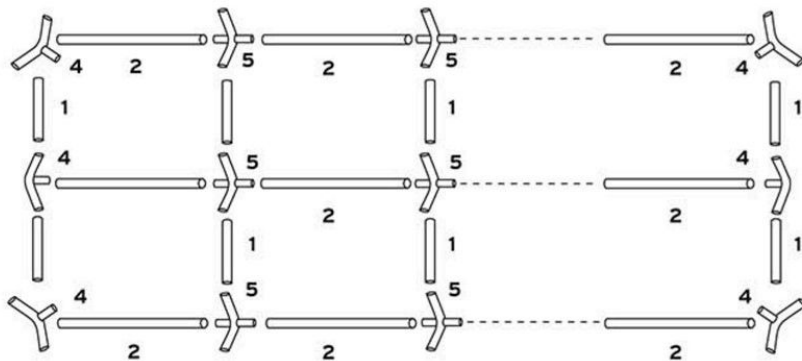

2

Levante una parte de la estructura de la carpa y coloque las patas (3 y 4). Coloque el techo (14) sobre el armazón y sujételo con los pasadores de goma (10). Procure que los pasadores de goma no queden muy tirantes para dificultar la colocación de la otra parte.

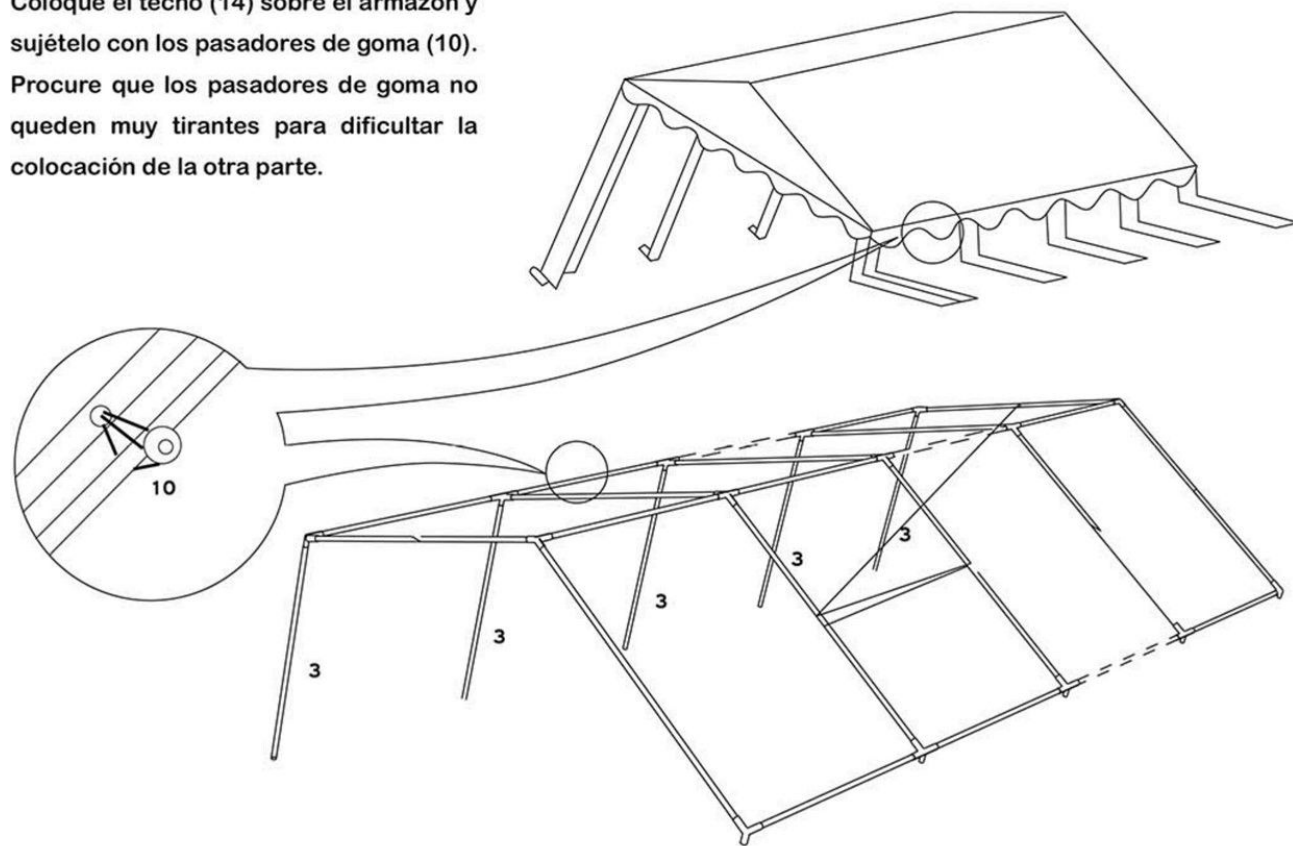

3

Coloque las patas de la parte contraria.
Utilice los clavos de tierra medianos (7)
para sujetar los pies al suelo. La
cubierta del techo se fija a las barras
(3) con los ganchos (13).

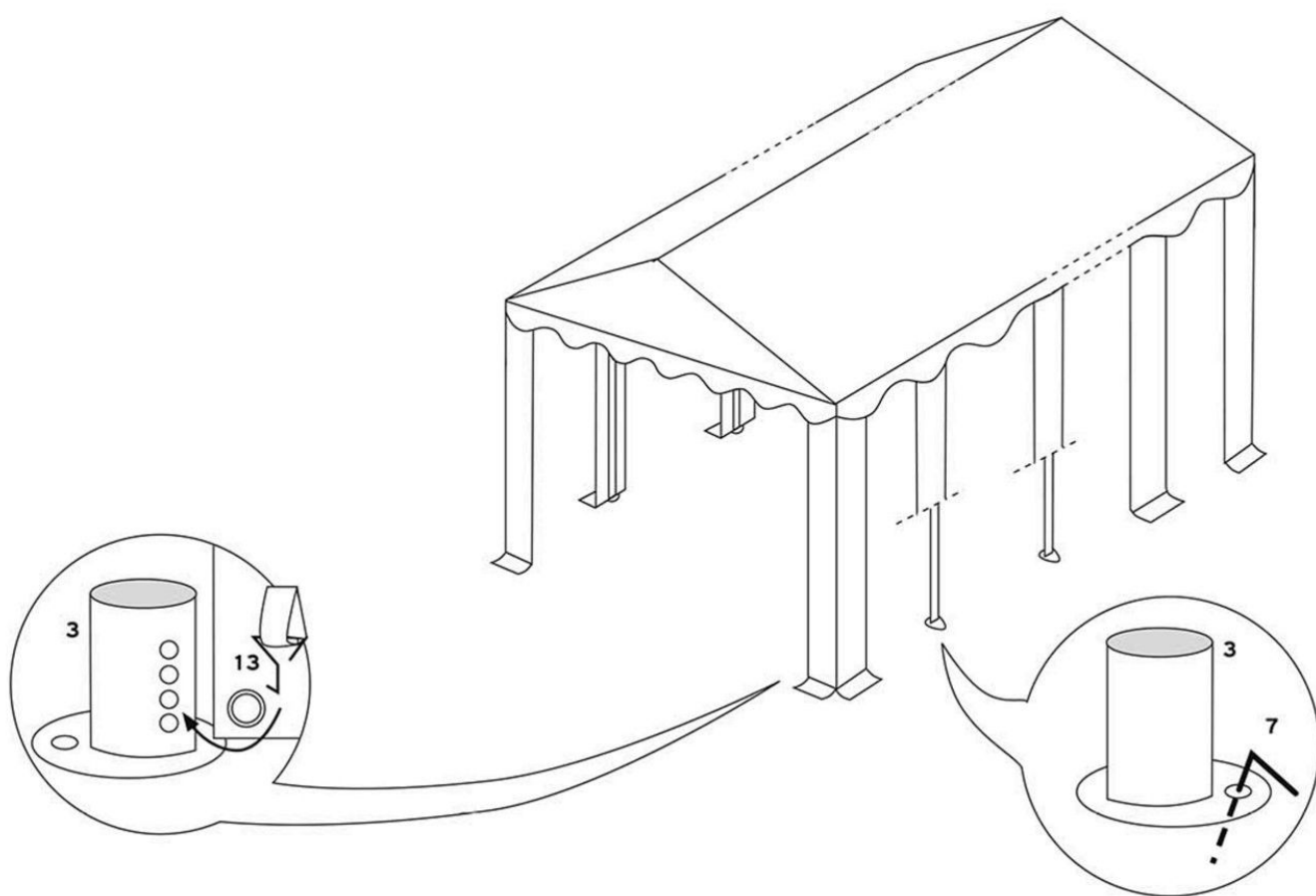

4

Extienda las paredes laterales (15) y finales (16) y sujete las paredes laterales con pasadores de goma (9) al armazón. Las paredes finales se fijan directamente al techo con los pasadores de goma cortos (10). Fije las paredes finales al suelo con los clavos de tierra cortos (8). La cuerda tensora se extiende desde cada esquina de la carpa y se sujeta al suelo con los clavos de tierra largos (6).

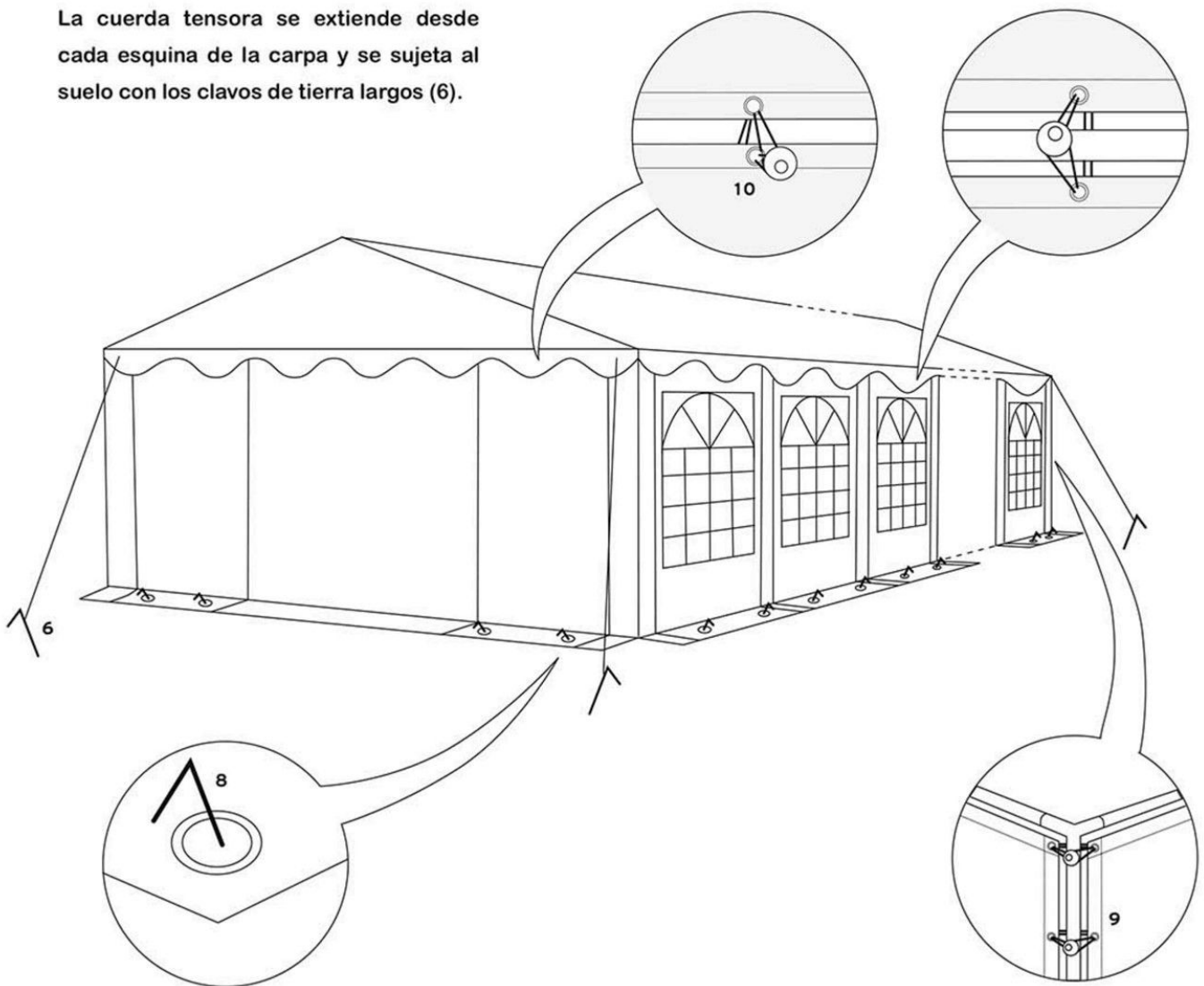

Limpieza y mantenimiento

El techo y las piezas laterales pueden lavarse con lejía jabonosa. Limpie el moho y las manchas de humedad con una solución suave de cloro. Siga las instrucciones del fabricante y pruebe la solución de cloro en una zona que no se vea para asegurarse de que no se produzcan decoloraciones.

¡Atención! No pliegue la carpa ni la embale si está húmeda, deje que antes se seque por completo

Advertencias

1. Procure manejar la carpa con cuidado para evitar daños.
2. No ejerza demasiada fuerza sobre las barras, ya que podrían dañarse.
3. Las carpas han sido diseñadas como alojamiento temporal y deben desmontarse en caso de condiciones atmosféricas desfavorables.
4. Procure que siempre haya una distancia adecuada con los tubos y conducciones de gas o electricidad para evitar que se dañen.
5. Si se utilizan calefactores adecuados (infórmese en un comercio especializado), se ha de mantener una distancia de al menos 1,2 metros con el material de las lonas. No haga nunca fuegos al aire libre ni utilice calefactores con llamas libres, como estufas para terrazas, calentadores de gas, etc.
6. La persona que instale la carpa es responsable de realizar un anclaje adecuado de la misma para garantizar su seguridad

CONTENT

Part no.	Description	ID no.		4x4m	4x6m	4x8m
30063	Pipe 2160 mm 38-38	1		6	8	10
30055	Pipe 1940 mm 38-38	2		6	9	12
30435	Pipe 1920 mm 38-38 with holes and foot	3		6	8	10
30073	Connector three way 120°	4		6	6	6
30074	Connector four way 120°	5		3	6	9
30048	Ground peg 8x300 mm	6		4	4	4
30046	Ground peg 6x180 mm	7		6	8	10
30047	Ground peg 4x160 mm	8		28	36	40
30430	Bungee 14 cm type 1	9		66	84	102
30429	Bungee 5 cm type 1	10		18	18	18
30050	Guy rope 3 m	11		4	4	4
30383	Screw 10 mm	12		30	42	54
30051	Roof hook	13		4	8	10
	Roof	14		1	1	1
	Side wall	15		4	6	8
	End wall	16		2	2	2

1

Select a flat surface for the tent. Unpack the boxes and check if all listed parts are included. Assemble the roof frame by mounting parts 4 to 5 on the pipes (parts 1 and 2). Use the screws to firmly attach the parts.

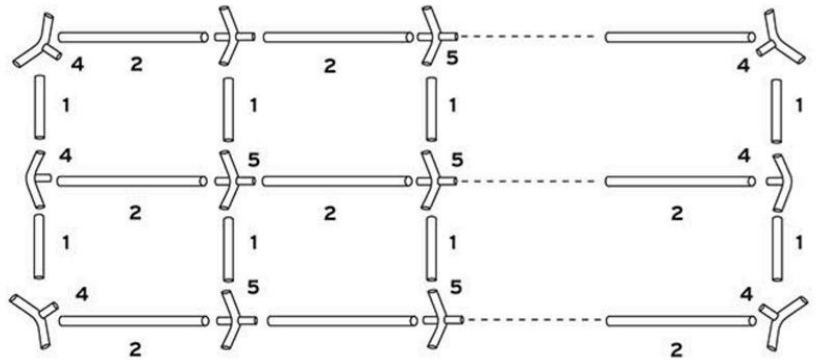

2

Lift one side of the tent frame and attach the legs (3). Place the roof (14) onto the frame and use the bungees (10) to fasten it. Be sure not to put too much tension on the bungees in order not to make attaching the other side more difficult.

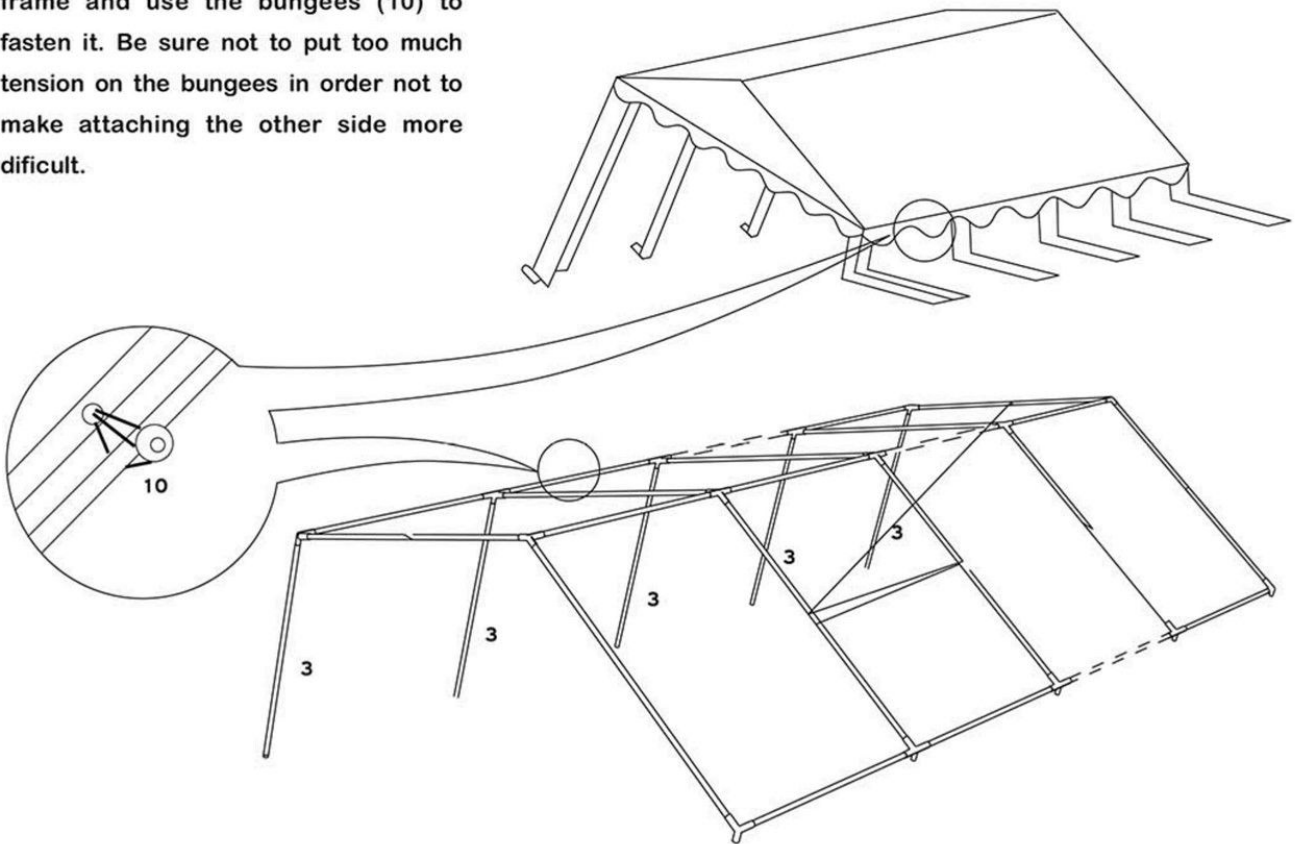

3

Attach the legs on the other side. Use the medium-size ground pegs (7) to fasten the feet to the ground. Attach the side covers to the pipes (3) using hooks (13).

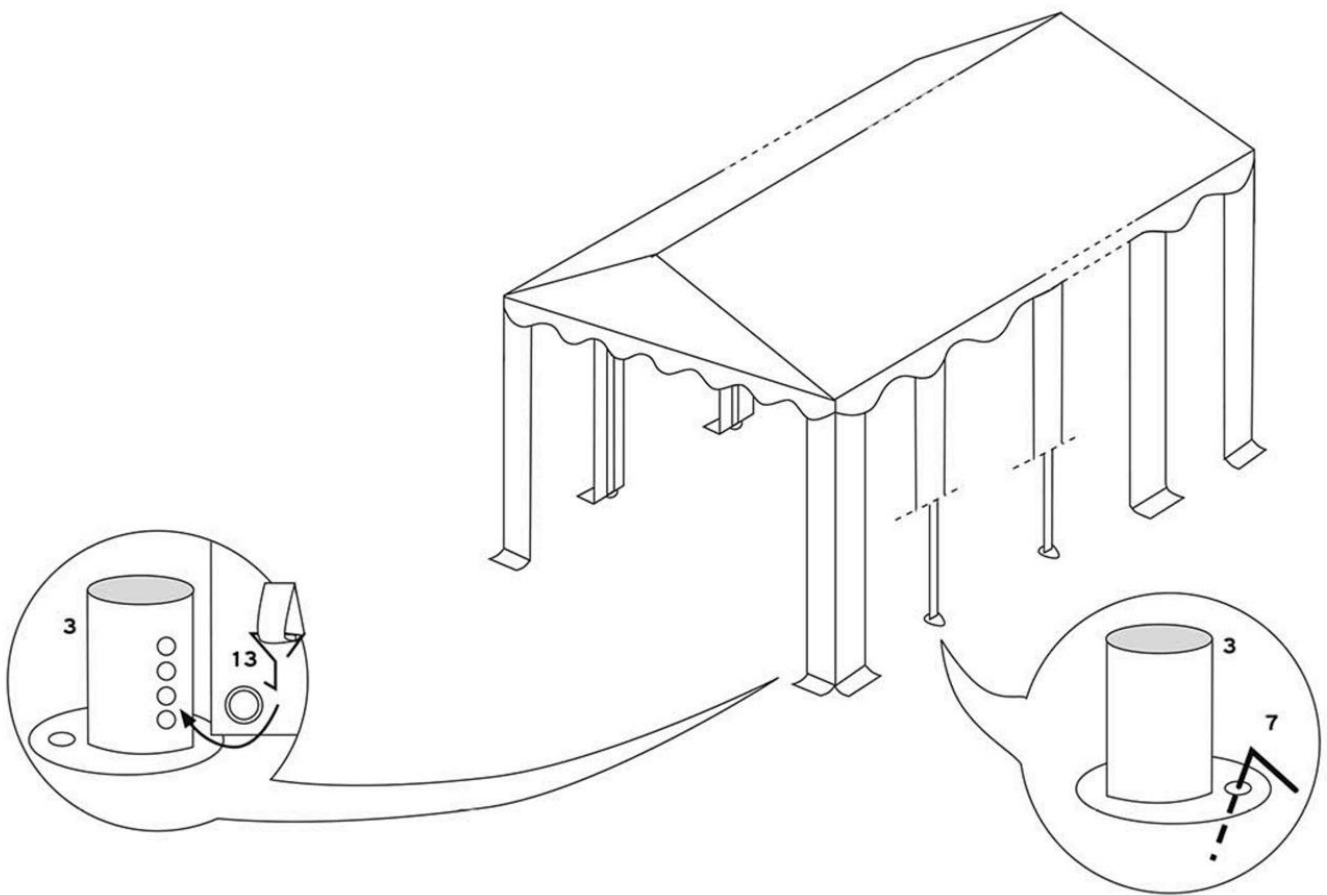

4

Extend the side walls (15) and the end walls (16) and attach the side walls to the frame using the bungees (9). Attach the end walls directly to the roof using the short bungees (10). Use the short ground pegs (8) to fasten the end walls to the ground. The guy rope runs from every corner of the tent and is braced to the ground using the long ground pegs (6).

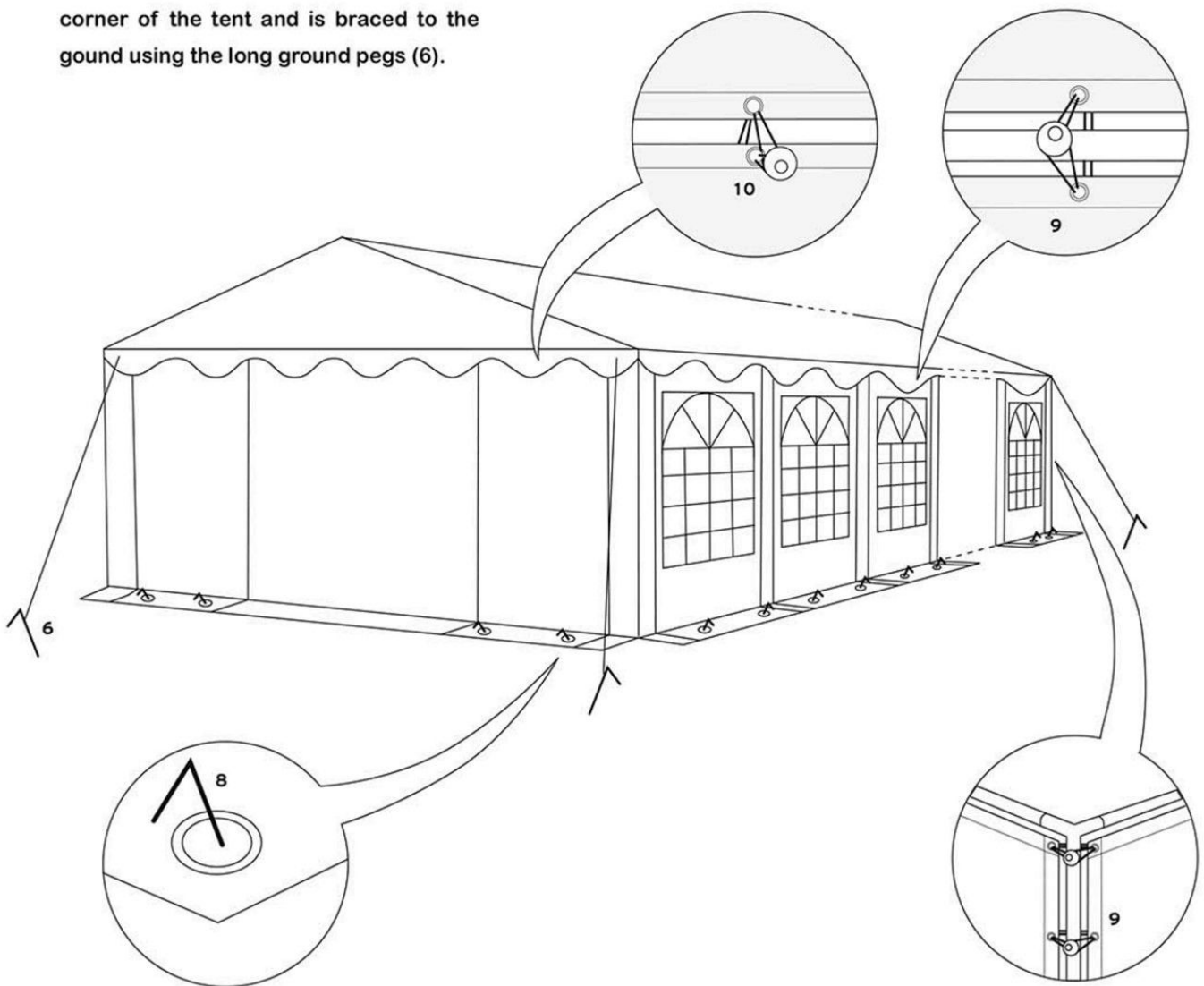







Cleaning and maintenance

Wash off the roof and the side parts with soapy water. Mould and mould stains can be removed using a mild chlorine solution. Observe the instructions provided by the manufacturer and test the chlorine solution on a hidden spot to make sure that there is no discolouration.

Caution! The party tent must not be collapsed and packed up when it is wet. First, allow it to dry completely.

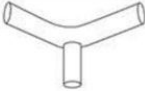
Caution

1. Always handle the tent with care to avoid damage.
2. Do not apply too much pressure to the frame parts to avoid damage.
3. Tents are intended for temporary accommodation and should be taken down in adverse weather conditions.
4. Always be sure to keep sufficient distance to hoses as well as gas and power lines to avoid possible damage.
5. When using suitable heaters (available e.g. in specialist shops), keep a minimum distance of 1,2 m to tarp material. Open fire or heaters with open flames such as patio heaters, umbrella heaters, gas heaters, etc. Should not be used in any case.
6. The person setting up the tent is responsible for adequately securing it to ensure its safety.

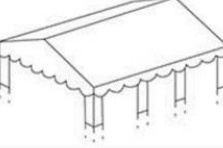
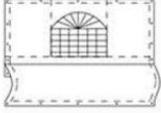
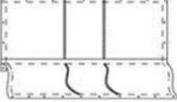
Code Art.	Désignation	N° de repère		4x4m	4x6m	4x8m
30063	Tube 2160 mm 38-38	1		6	8	10
30055	Tube 1.940 mm 38-38	2		6	9	12
30435	Tube 1.920 mm 38-38 avec trous et pied	3		6	8	10
30073	Raccord 3 axes 120°	4		6	6	6
30074	Raccord 4 axes 120°	5		3	6	9
30048	Piquet de sol 8x300 mm	6		4	4	4
30046	Piquet de sol 6x180 mm	7		6	8	10
30047	Piquet de sol 4x180 mm	8		28	36	40
30430	Boucle caoutchouc 14 cm type 1	9		66	84	102
30429	Boucle caoutchouc 5 cm type 1	10		18	18	18
30050	Cordeau tendeur 3 m	11		4	4	4
30383	Vis 10 mm	12		30	42	54
30051	Crochet de toit	13		4	8	10
	Toit	14		1	1	1
	Paroi latérale	15		4	6	8
	Paroi d'extrémité	16		2	2	2

1

Cherchez un endroit où le sol est plan pour installer la tente. Déballez les cartons et vérifiez que toutes les pièces figurant dans la liste ci-dessus sont présentes. Assemblez le cadre du toit en montant les pièces 4 et 5 sur les tubes (pièces 1 et 2) et en bloquant les vis pour fixer le tout.

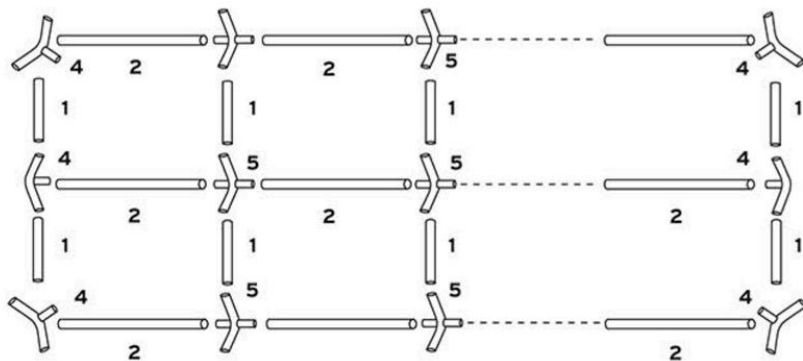

2

Soulevez un côté de l'ossature de la tente et emmanchez les montants (3). Posez le toit (14) sur le cadre et fixez-le au moyen des tendre exagérément les boucles en caoutchouc (10) afin de ne pas rendre le montage de l'autre côté plus difficile.

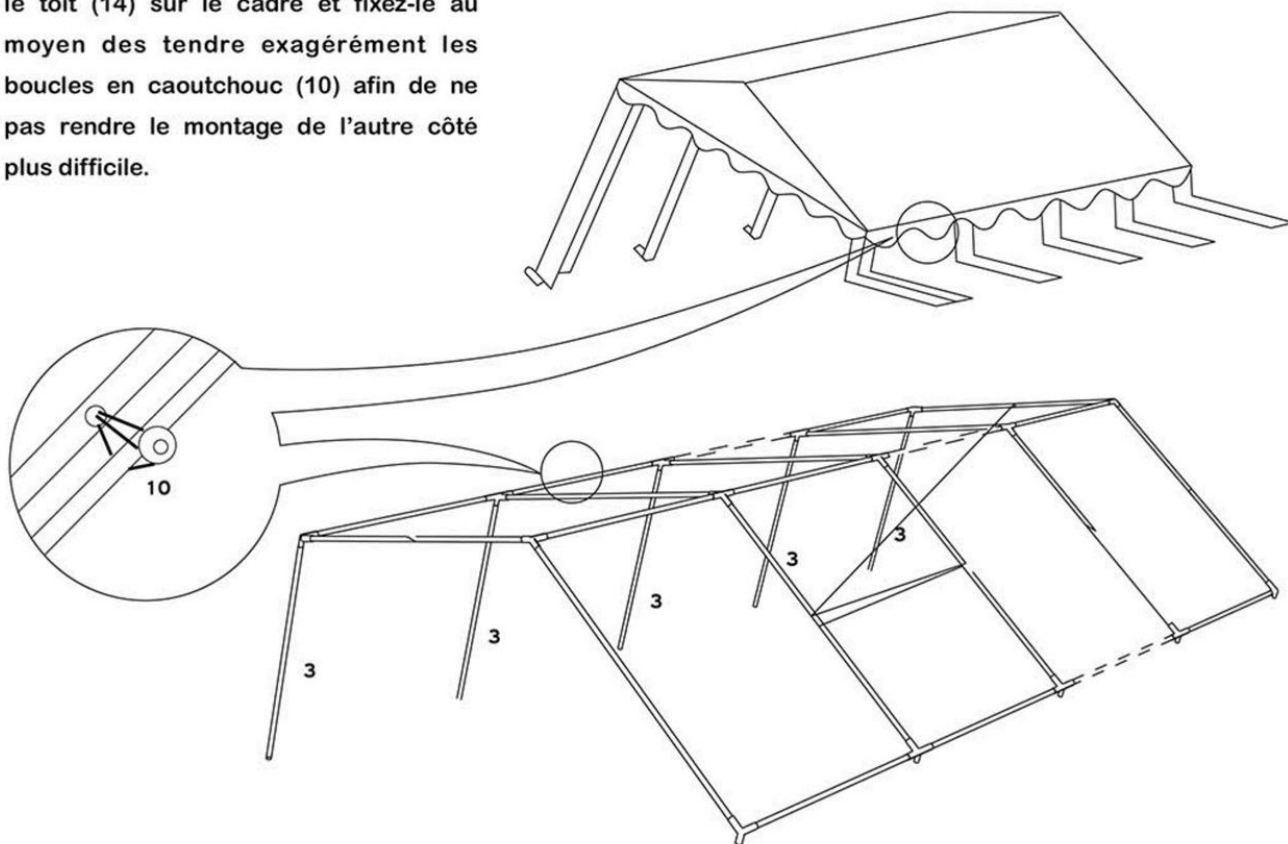

3

Emmanchez les montants du côté opposé
Utilisez les piquets moyens (7) pour immobiliser les pieds au sol. L'habillage du toit se fixe aux tubes (3) au moyen de crochets (13).

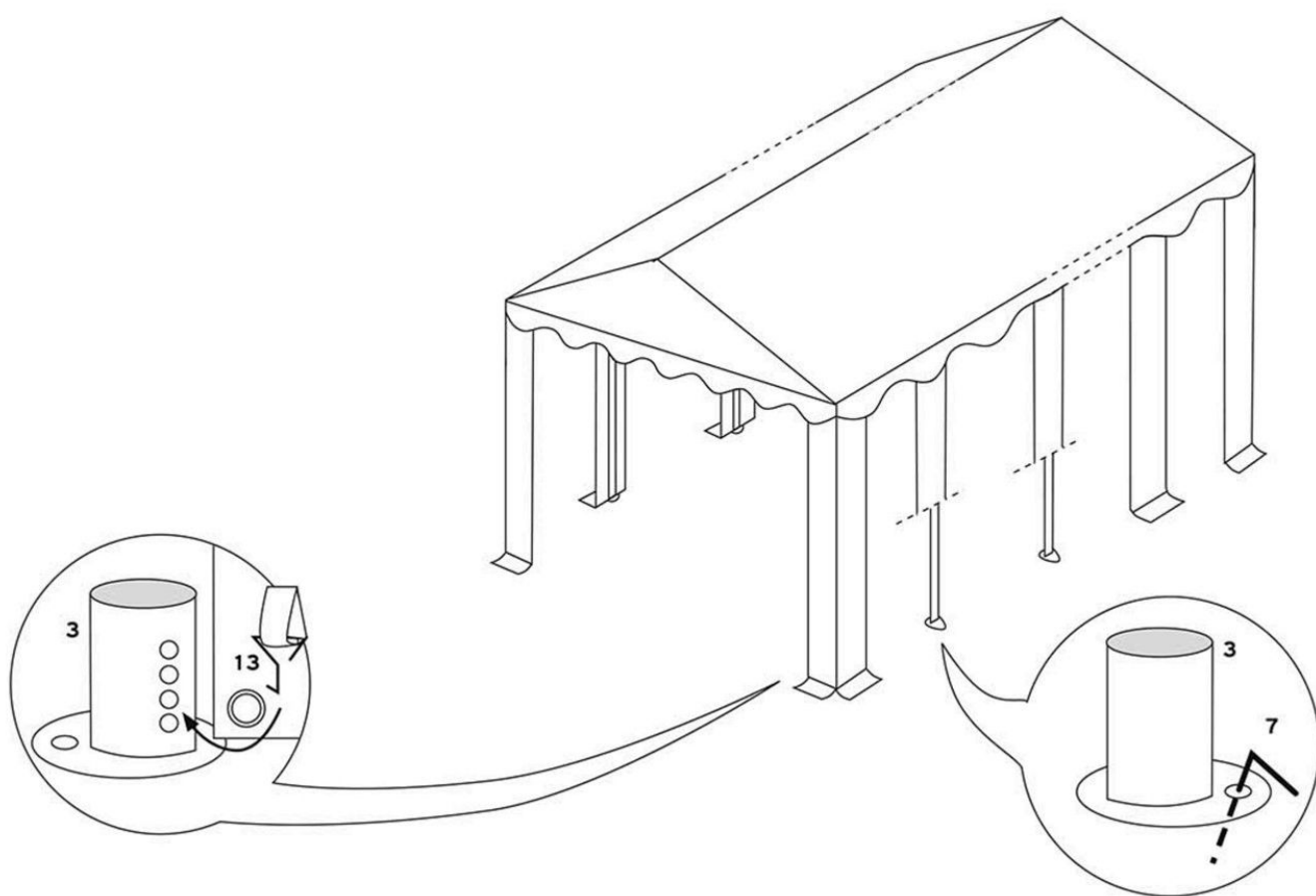

4

Écartez les parois latérales (15) et les parois d'extrémité (16) et fixez les parois latérales à l'ossature au moyen des boucles en caoutchouc (9) et les parois d'extrémité au sol à l'aide des piquets courts (10). Le cordeau tendeur part de chaque angle de la tente et il est tendu au sol au moyen des piquets longs (6).

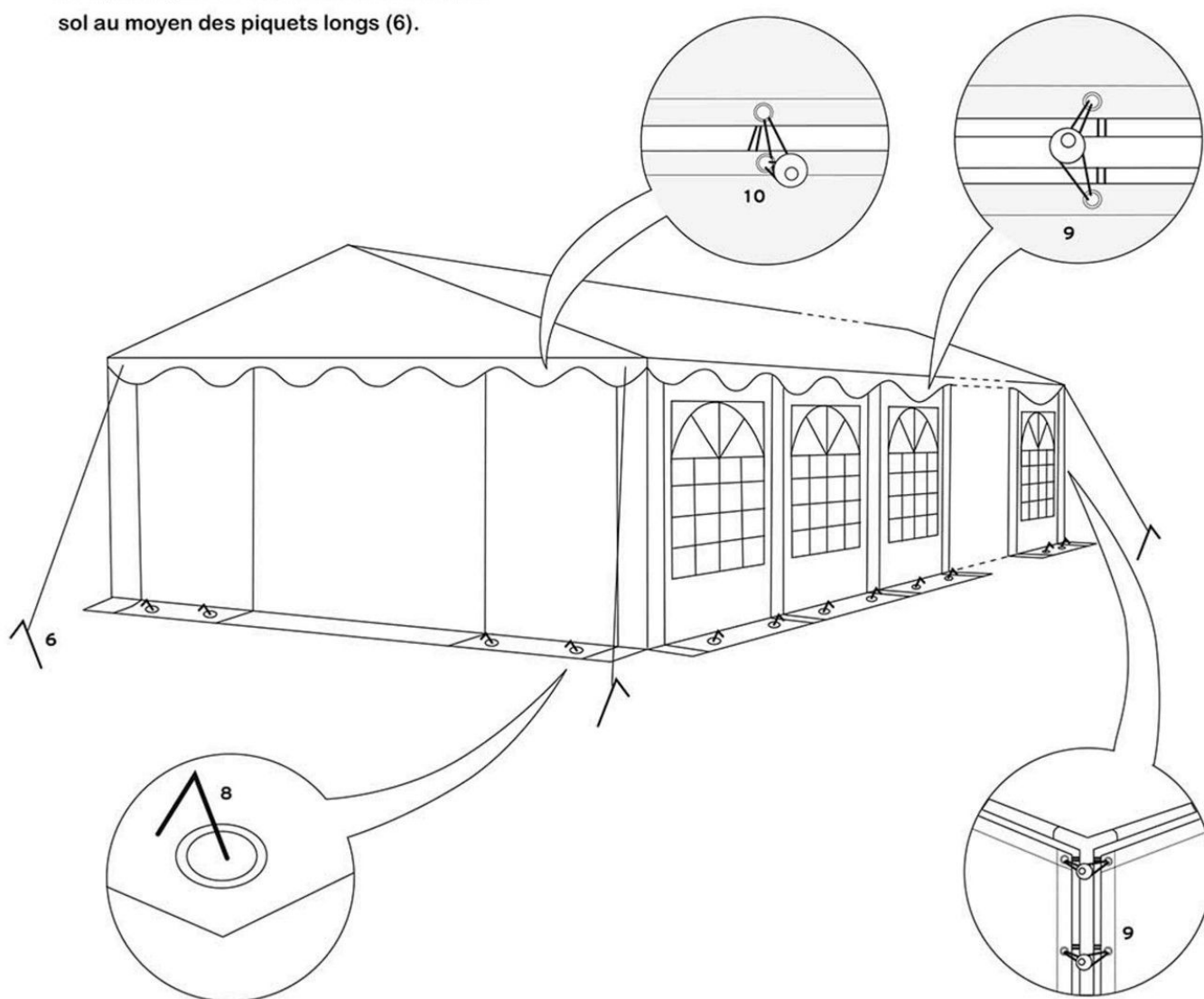

Nettoyage et entretien

Le toit et les parois se lavent à l'eau savonneuse. Pour éliminer les moisissures et les taches d'humidité, utilisez une solution légèrement chlorée. Suivez les instructions du fabricant et testez la solution chlorée à un endroit non visible pour vous assurer qu'elle ne provoque pas de décoloration.

Attention! La tente de réception ne doit en aucun cas être repliée et rangée lorsqu'elle est humide. Laissez-la sécher complètement auparavant.

Avertissements

1. Veillez à manipuler la tente avec précautions pour éviter de la détériorer.
2. Évitez de forcer sur les tubes et les raccords, au risque de les endommager.
3. Les tentes sont destinées à des usages de loisirs temporaires et elles doivent être démontées en cas de mauvais temps.
4. Veillez à respecter systématiquement une distance appropriée par rapport aux tuyaux, aux conduites de gaz ou aux lignes électriques afin d'éviter de les endommager.
5. En cas d'utilisation d'appareils de chauffage adaptés (se renseigner par exemple auprès d'un vendeur spécialisé), respectez une distance minimum de 1,2 m par rapport à chaque matériau de bâchage. Les feux ouverts de terrasses, chauffages au gaz etc. ne doivent en aucun cas être utilisés.
6. L'installateur est responsable de l'ancrage adéquat et donc de la sécurité de la tente.

CONTEÚDO

Nº de art.	Descrição	Nº de ident.		4x4m	4x6m	4x8m
30063	Barra 2160 mm 38-38	1		6	8	10
30055	Barra 1.940 mm 38-38	2		6	9	12
30435	Barra 1.920 mm 38-38 con furos	3		6	8	10
30073	Conector angular triplo 120°	4		6	6	6
30074	Conector angular quádruplo 120°	5		3	6	9
30048	Prego de solo 8x300 mm	6		4	4	4
30046	Prego de solo 6x180 mm	7		6	8	10
30047	Prego de solo 4x180 mm	8		28	36	40
30430	Passador de elástico 14 cm tipo 1	9		66	84	102
30429	Passador de elástico 5 cm tipo 1	10		18	18	18
30050	Corda tensora 3 m	11		4	4	4
30383	Parafuso 10 mm	12		30	42	54
30051	Gancho de teto	13		4	8	10
	Teto	14		1	1	1
	Parede lateral	15		4	6	8
	Parede final	16		2	2	2

1

Busque uma superfície plana para instalar a tenda. Abra a embalagem e comprove se estão todas as peças que aqui se enumeram. Ensamble a armação do teto montando as peças de 4 a 5 nas barras (peças 1 e 2) e aperte os parafusos para fixá-las

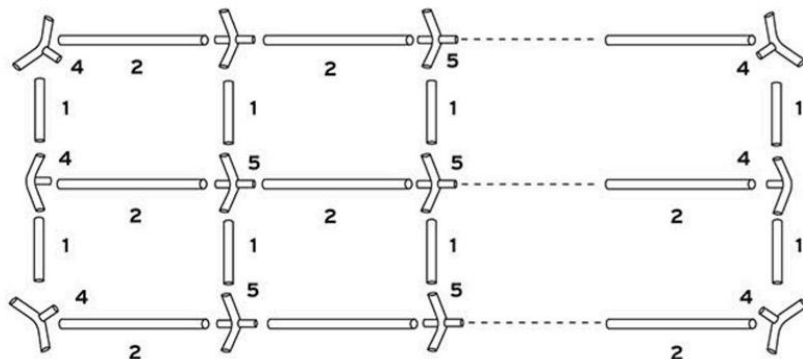

2

Levante uma parte da estrutura da tenda e coloque as patas (3). Coloque o teto (14) sobre a armação e prenda-a com os passadores de elástico (10). Procure que os passadores de elástico não fiquem muito apertados para não dificultar a colocação da outra parte.

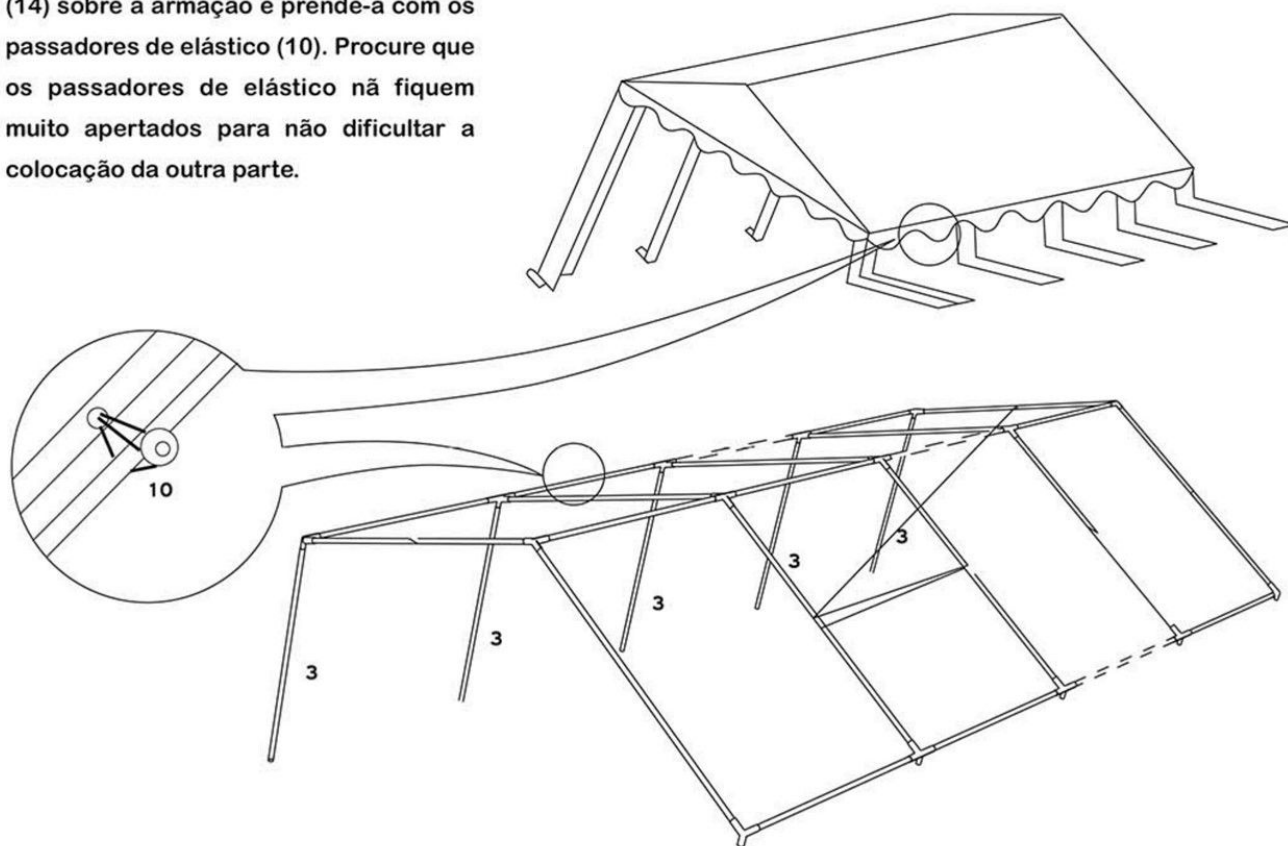

3

Coloque as patas da parte contrária.
Utilize os pregos de solo (7) para
prender os pés ao solo. A cobertura do
teto se fixa às barras (3) com ganchos(13)

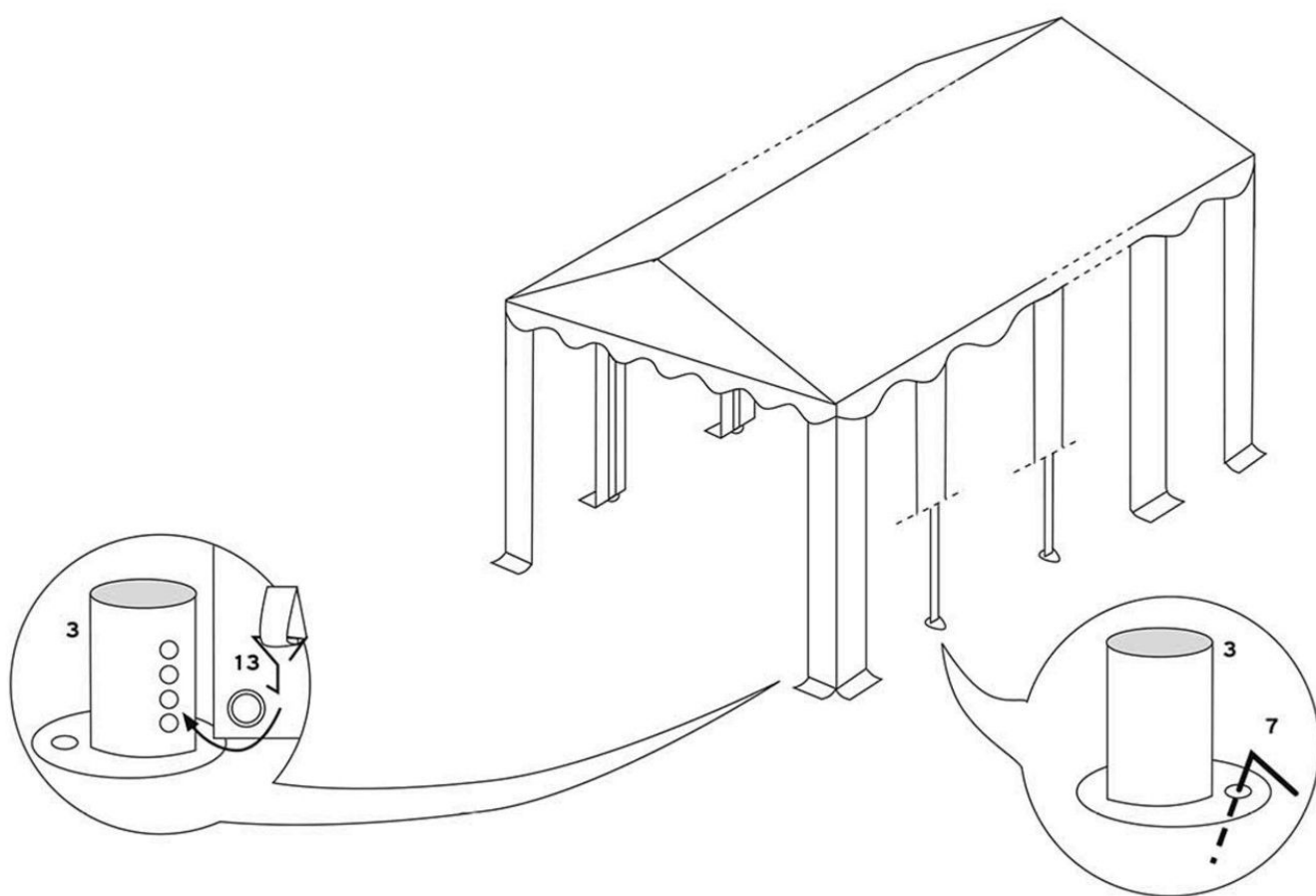

4

Estenda as paredes laterais (15) e finais (16) e prenda as paredes laterais com os passadores de elásticos (9) à amação. As paredes finais se fixam diretamente ao teto com os passadores de elástico curtos (10). Fixie as paredes finais ao solo com os pregos de solo curtos (8). A corda tensora se estende desde cada esquina da tenda e se prende ao solo com o gancho roscado (6)

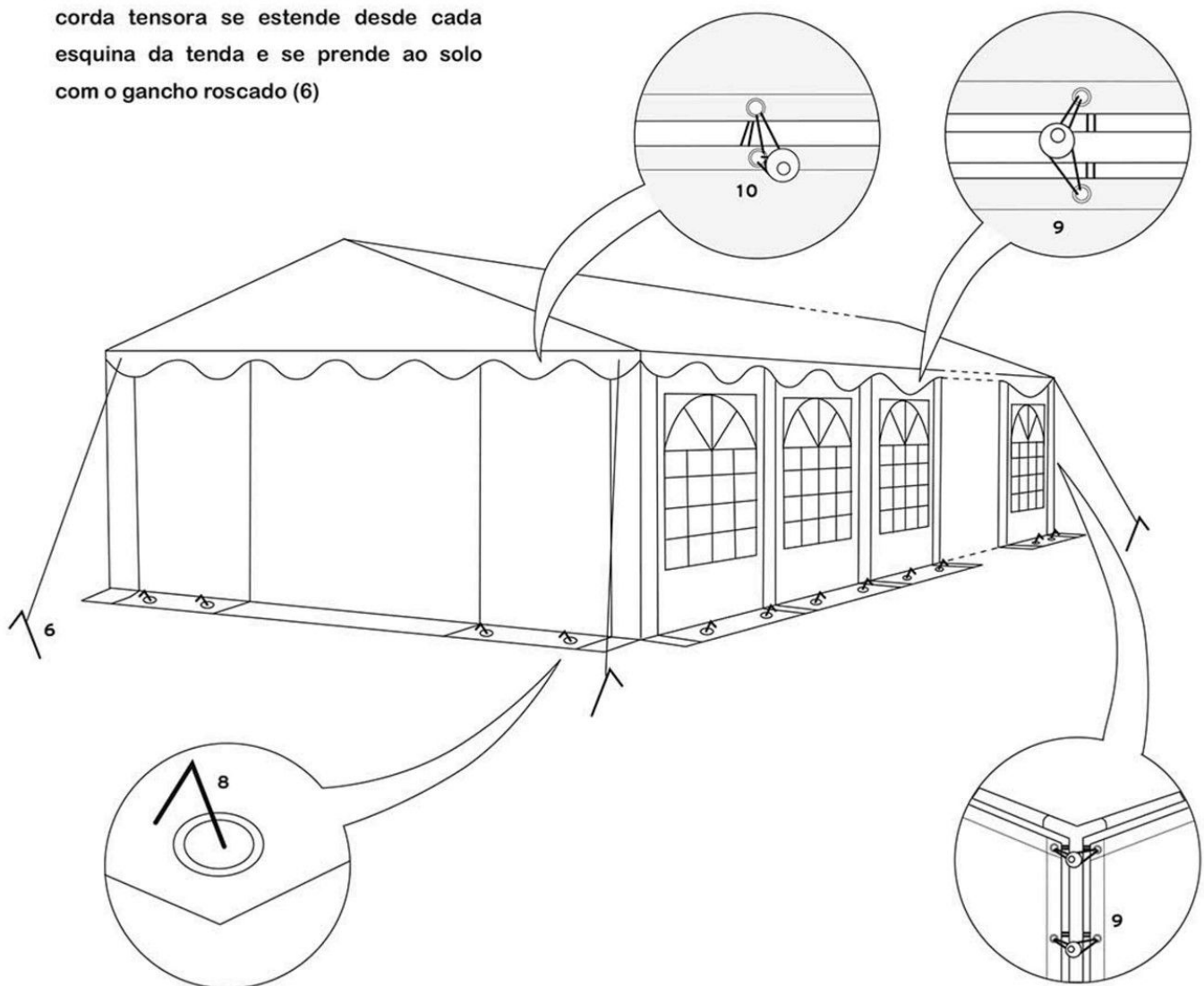

Limpeza e manutenção

O teto e as peças laterais se podem lavar com lixívia saponácea. Limpe o mofo e as manchas de umidade com uma solução suave de cloro. Siga as instruções do fabricante e experimente a solução de cloro em uma zona que não se veja para assegurar-se de que não se produzam descolorações. .

Atenção! Não dobre a tenda nem a embale se está úmida, deixe que antes se seque por completo.

Advertências

1. Procure manejar a carpa com cuidado para evitar danos.
2. Não exerça demasiada força sobre as barras, já que poderiam estragar-se.
3. As tendas foram desenhadas como alojamento temporal e devem desmontar-se em caso de condições atmosféricas desfavoráveis.
4. Procure que sempre haja uma distância adequada com tubos e conduções de gás ou eletricidade para evitar que se estraguem.
5. Se se utilizam calefatos adequados (informe-se em um comércio especializado), se deve manter uma distância de ao menos 1,2 m com o material das lonas. Não faça nunca fogo ao ar livre nem utilize calefatos com chamas livres, como estufas para varanda, aquecedores a gás, etc.
6. A pessoa que instale a tenda é responsável de realizar uma ancoragem adequada da mesma para garantir sua segurança.

